

# WIN STORE

AUTOMATED STORAGE

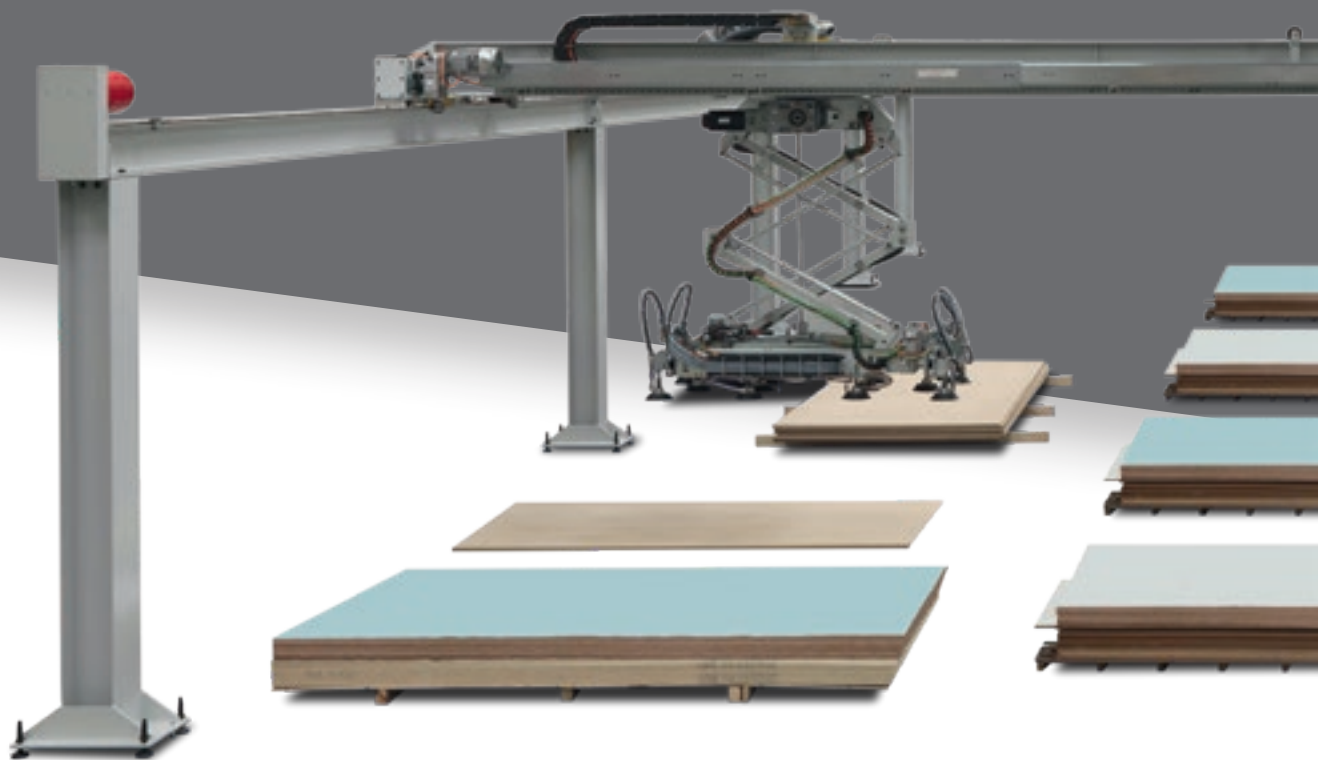

# MANUFACTURING WHAT YOU NEED WHEN YOU NEED IT



## THE MARKET EXPECTS

a change in manufacturing processes which enables companies to **accept the largest possible number of orders**. This is coupled with the need to maintain high quality standards and **high productivity** for products manufactured in a large number of variants, **with quick and defined delivery times**. It is no longer possible to predict production volumes with any certainty, so you cannot afford to build up costly inventory that eventually becomes obsolete.

## BIESSE RESPONDS

with **high-tech solutions** that can meet the technical requirements of contract manufacturers, thus considerably reducing costs and cycle times. **Winstore** is an automated storage for the optimised management of panels for large contract manufacturers, which guarantees production with reduced times and costs. Winstore can be integrated into nesting and sizing cells with a significant increase in productivity.

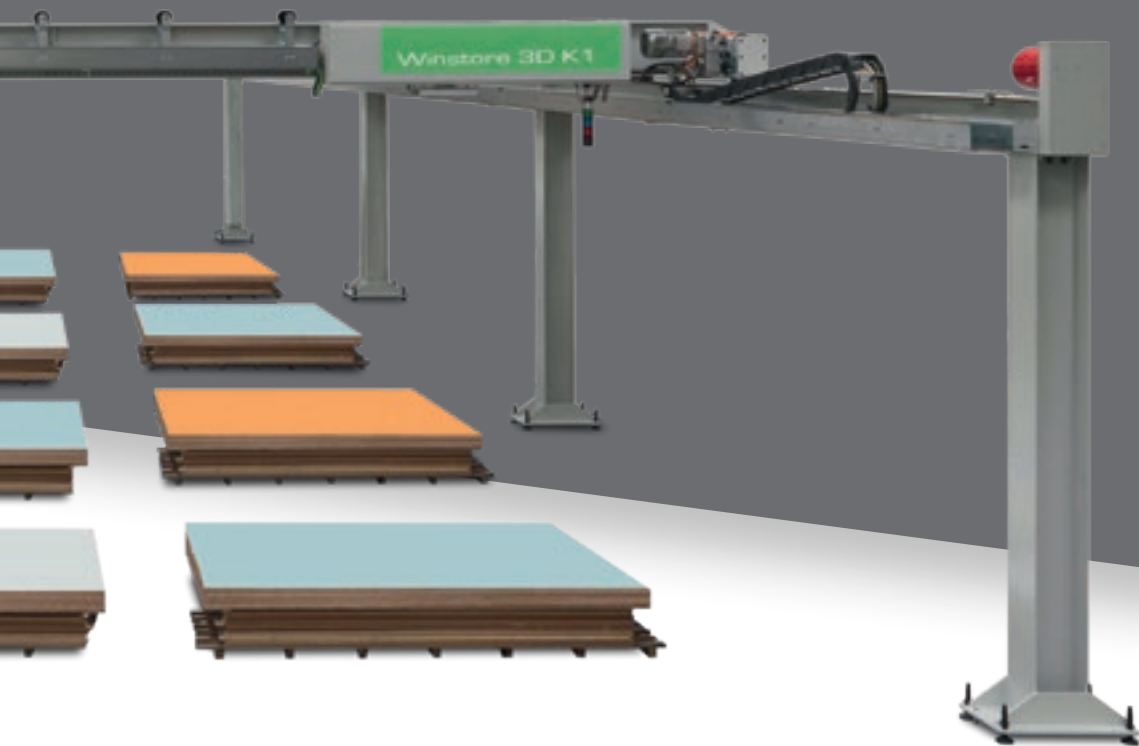

# WINSTORE

- ✓ RETURN ON INVESTMENT WITHIN ONE YEAR THANKS TO INCREASED EFFICIENCIES AND COST REDUCTION
- ✓ PRODUCTION FLOW OPTIMISATION
- ✓ INTEGRATION IN THE PRODUCTION LINE
- ✓ INTEGRATION WITH PRODUCTION MANAGEMENT SOFTWARE

# A SOLUTION FOR EVERY NEED



Biesse offers the most complete range of solutions for the storage and handling of panels, transforming production context needs into reality.

▣ **WINSTORE X3**  
COMPACT  
AND RELIABLE

Up to 300 coated panels per shift

▣ **WINSTORE X2**  
HIGH PERFORMANCE  
AND FUNCTIONALITY

500 panels per shift



Thanks to its vast range,  
Winstore is able to welcome any challenge.

▣ **WINSTORE 3D K1**  
**TOP OF THE RANGE,**  
**MAXIMUM CONFIGURABILITY**  
**400 Panels per shift**

# MULTIPLE CUSTOMISABLE CONFIGURATIONS FOR DIFFERENT PRODUCTION NEEDS

Cells can be customised with respect to sizing and nesting capability and based on the storage's size and characteristics.

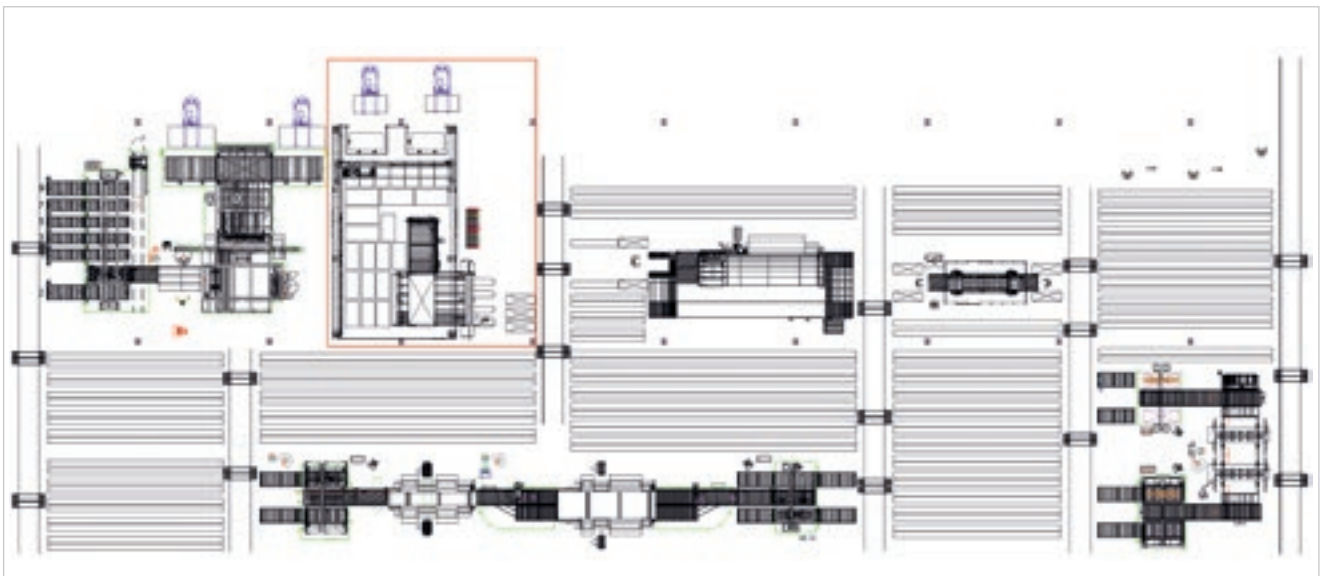

## WINSTORE 3D K1

Configuration designed for high-volume manufacturers who need to respond to increasing product flexibility. On average

the Winstore K1 can handle up to **400 panels per shift** (average value for a 7 hour shift).

Above is an example of a factory where Winstore K1 was integrated into their overall production facility, for the production of a wide variety of components.

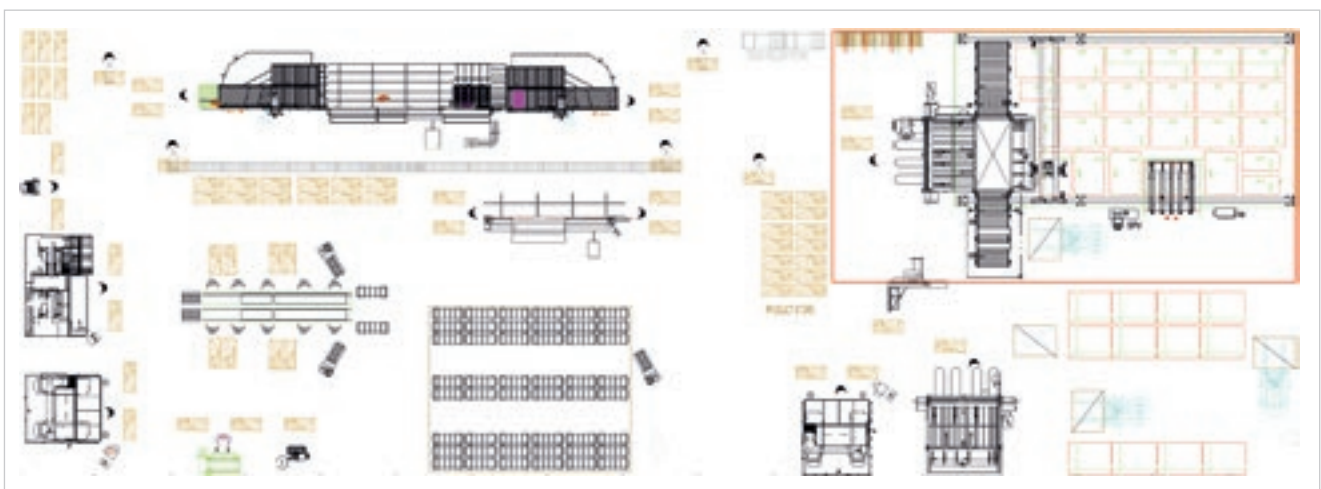

## WINSTORE X3

Configuration dedicated for manufacturers who require high production flexibility.

Winstore X3 can handle up to **300 panels per shift** (average value for a 7-hour shift).

Above is an example of a factory where the Winstore X3 was the starting point for the whole integrated production process.

## APPLICATION FIELDS

- On-demand production
- Small-batch production
- Batch one production
- Production of different sized components

- Production of low volume components
- Prototype production
- Production of urgent panels
- Production of missing panels

PRODUCTIVITY ↑

WINSTORE 3D K1



WINSTORE + 2 SELCO + ROVER

WINSTORE 3D K1  
WINSTORE X2



WINSTORE + SELCO + ROVER

WINSTORE X3



WINSTORE + SELCO + ROVER

→ FLEXIBILITY

# RETURN ON INVESTMENT WITHIN 1 YEAR

Production line performance increase  
of up to 25% when working in real time processing.

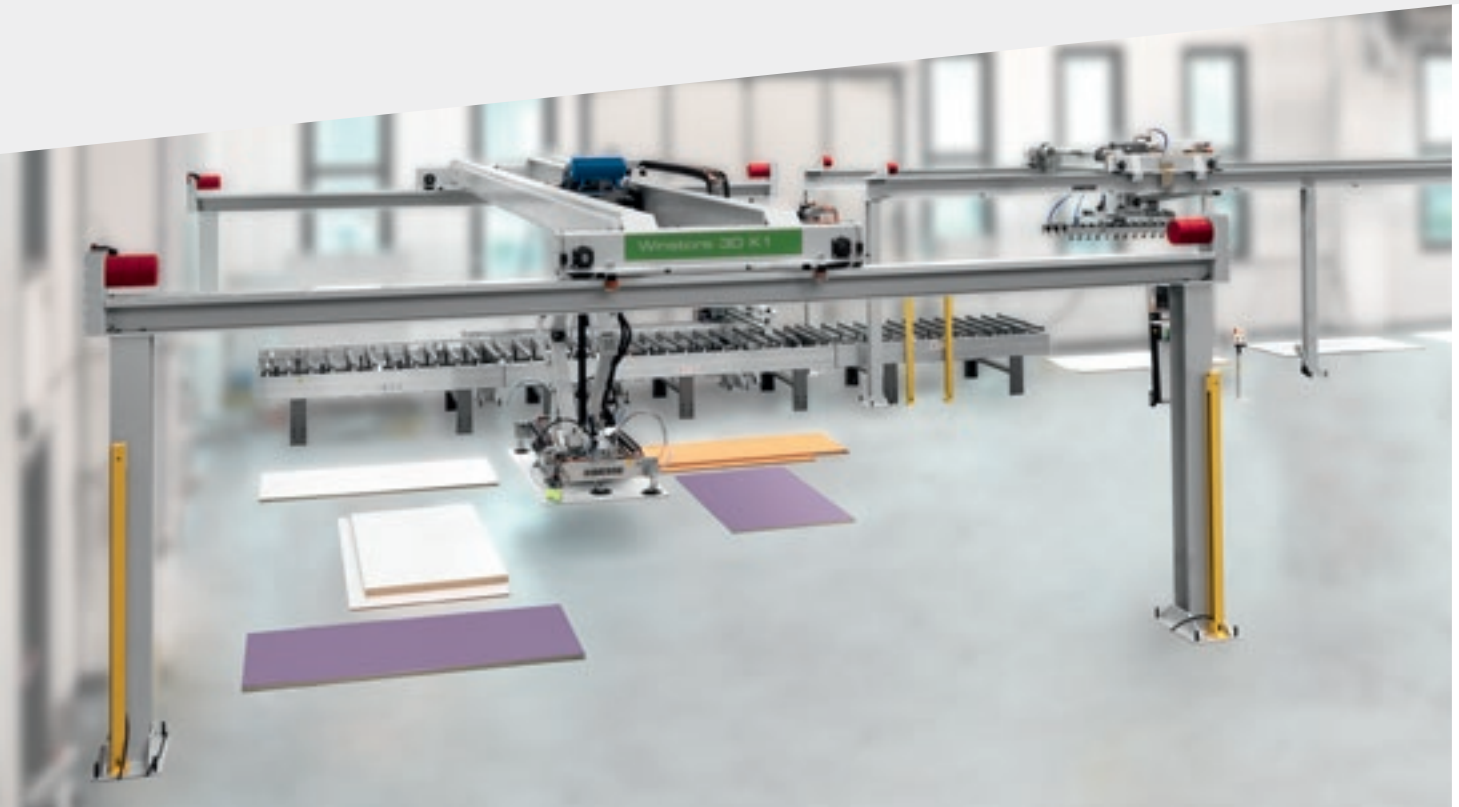

Winstore **stacks panels of different sizes and materials**, including mixed ones, with no need for operator intervention. The reorganisation of the panel storage and stacking can be carried out automatically, and out of working hours.

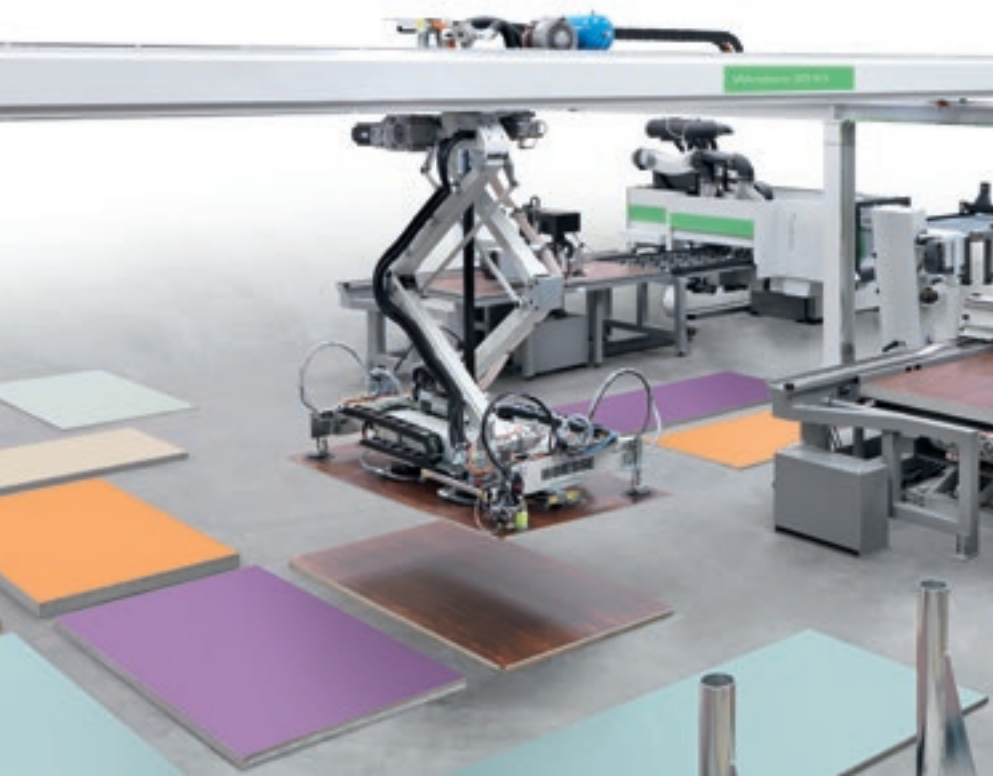

## 35% REDUCTION OF PRODUCT DELIVERY TIME COMPARED TO CONVENTIONAL SOLUTIONS

Storage mapping is fully optimised thanks to the **panel automatic handling** managed by the system supervision software. The **panel scissor pick-up mechanism** enables installation in low-height areas, as well as supporting high system performance and guaranteeing optimal panel stability.





## 10% REDUCTION IN RAW MATERIALS COMPARED TO CONVENTIONAL PRODUCTION HANDLING METHODS

The **rotating panel pick-up system** and **squaring laser photocells** optimise the storage internal area enabling the perfect alignment of the stack as well as correcting manual loading errors. Waste reduction.



## 30% LABOUR REDUCTION

Greater efficiency of floor and storage space due to the management of multi-sized and multi-coloured stacks.



# WINSTORE X3: RELIABILITY AND TOP PERFORMANCE

The Winstore X3 storage system is an easy to configure solution created to meet the need for integration for the entry-level machine range.



WATCH THE VIDEO

## PRODUCTIVE AND COMPACT

The rigid, compact, single-piece structure can withstand exceptional dynamics and weights whilst maintaining the same degree of reliability.



Absolute encoders provide retroactive checks on every axis, to eliminate the reset phases after an emergency stop or machine restart and hence improve productivity.

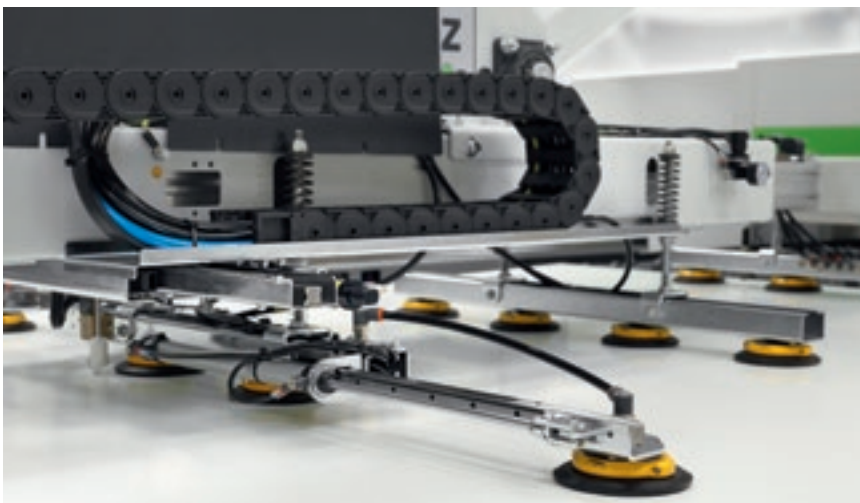

The suction cup frame is fitted with two extendible suction cups that can support even the thinnest panels in line with the angle gauge check device. This avoids any read errors while the angle gauge is making the check, with the subsequent need for the operator to reset the machine.



At the ends of the frame there are two photocells that verify the secure grip on the panel, preventing any movement of unstable panels.

# ELEVATED SAFETY AND STABILITY WHEN HANDLING PANELS



WinstoreX3 is designed to meet the needs of customers looking for user-friendly solutions and the right balance between reliability and limited investment.

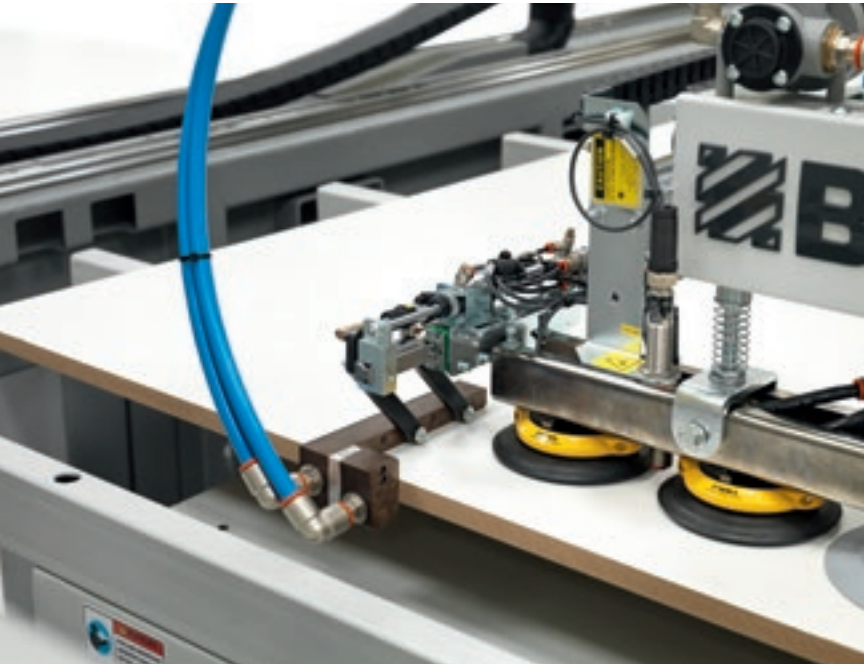

## DEVICE FOR DETACHING BREATHABLE MATERIALS

Air jet device for detaching breathable materials. Automatic jet adjustment in two material thickness ranges to boost detachment efficiency and machine productivity.

# WINSTORE X2: HIGH PERFORMANCE AND FUNCTIONALITY



Winstore X2 is a configuration designed for customers who demand high performance and a significant increase in productivity for efficient and personalised production.



Significantly boosts performance and productivity thanks to the higher speed of the axes and angle gauge check with moving axes.

**OPTION OF MACHINING  
500 PANELS PER SHIFT:  
WINSTORE X2 IS THE MOST  
PRODUCTIVE MACHINE  
IN THE RANGE.**

## STURDINESS AND RELIABILITY

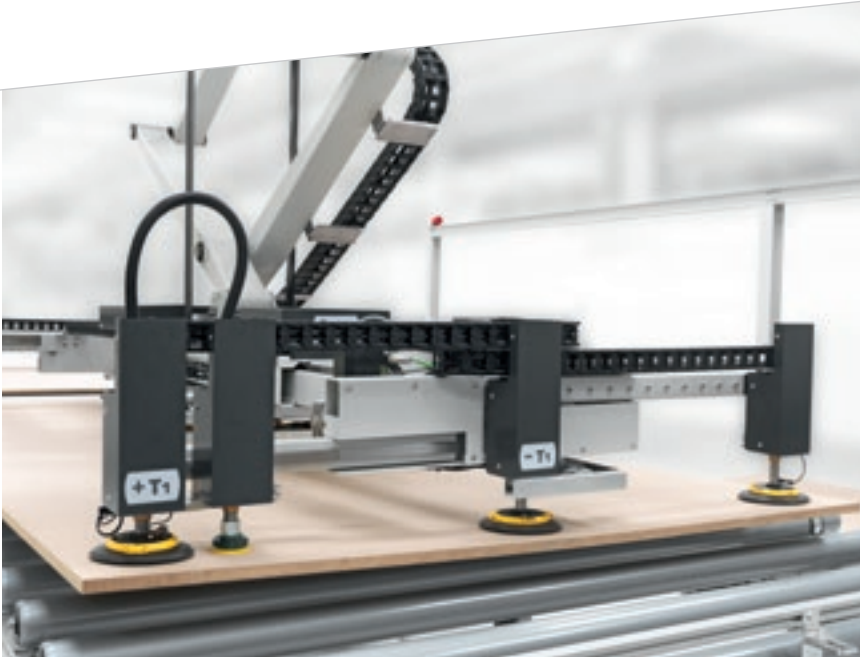

Handles thin panels with minimum thickness as low as 2.5 mm. Winstore X2 consists of groups of 3 suction cups that are located on the front part of the frame for the optimal management of thin panels and moved by pneumatic cylinders in repeated and alternating cycles.

Vacuum management on the suction cup frame can be adjusted, software parameters can automatically activate or exclude each suction cup, facilitating the release of rough and thin materials.



The new double parallelogram router ensures increased sturdiness, allowing for the safe management of heavier weights.

# COMPLETE TRACEABILITY

Panels are traceable thanks to the automatic labelling system, complete with printer.



The labelling system consists of 2 brushless axes that move over the panel and apply the adhesive label to the position set by the supervisor on the basis of the cutting plan. The axes move along linear guides by rack and pinion.

**NEW ELECTRIC PANEL WITH CONDITIONER FOR ULTIMATE RELIABILITY UNDER ALL CONDITIONS.**





## EVERYTHING UNDER CONTROL



### CAMERA SYSTEM FOR MONITORING

The system consists of two cameras used to monitor the machine, verifying correct operation in real time. One camera is located on the Y beam and the other on the carriage, to provide a better view of the phases of operation for Winstore.

The systems allows the operator to efficiently monitor and manage the manufacturing process, phase by phase, from the office. The work phases can be stored, allowing the operator to check any malfunctions and address them promptly.

# SAFE AND HIGHLY AUTOMATED HANDLING

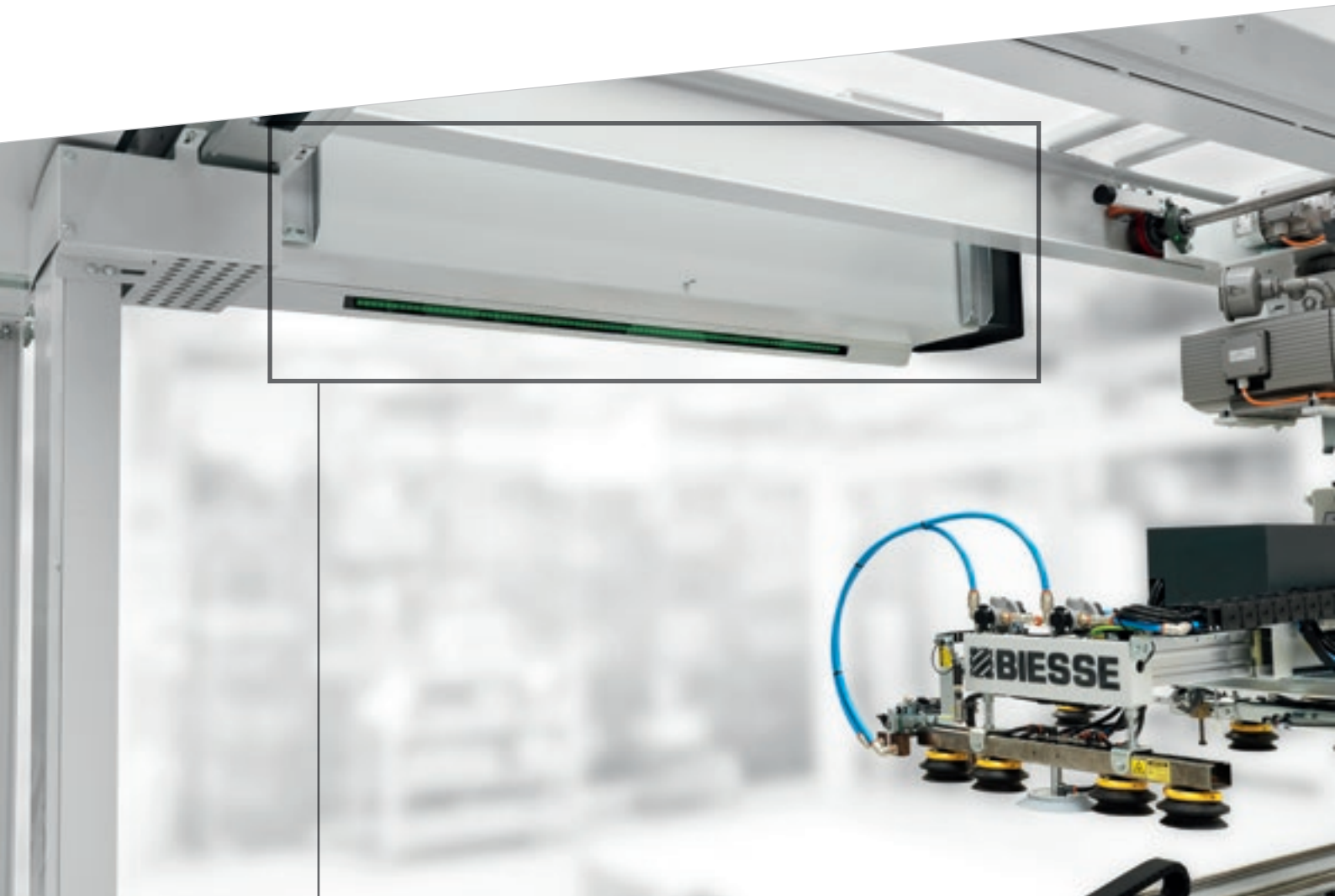

LED bar showing the machine status, visible from any point to ensure better control for the operator at all times.

## SAFETY AND PROTECTION IN EVERY PHASE OF PRODUCTION



### TOUCHSCREEN OPERATOR PANEL POSITIONED:

- ✔ ON THE SAFETY BARRIER POLE IN THE LOADING BAY
- ✔ ON THE CELL INSPECTION GATE

If the machine stops during machining, the operator can reset it directly from the access point without having to go to the command console.

In addition, the machine is equipped with a new PILZ safety switching box for enhanced safety component quality. Thanks to the switching box, the safety device logic can be planned at software level, offering a more flexible solution for the customer's requests.

# LEAN AND EFFICIENT PRODUCTION FLOW





## DESIGN OF INTEGRATED LINES OVER 100 METRES LONG

BiesseSystems provides a full project consultancy and management service to companies who wish to implement integrated technology solutions for their manufacturing processes.

A team of sector experts, capable of understanding and anticipating company needs, work with the customer from inception through to system installation and commissioning.

## OVER 1000 SYSTEMS SOLD WORLDWIDE

- ✔ Design and installation of turn-key systems.
- ✔ Design and installation of automated and integrated production lines.
- ✔ Upgrading, refurbishment and integration of pre-existing production systems.

# FULL INTEGRATION WITH NESTING MACHINING CENTRES AND PANEL SAWS

WINSTORE + CNC Nesting



WATCH THE VIDEO



Thanks to the proximity and availability of the panels, it is possible to substantially increase cell productivity compared to manual loading methods using a forklift truck.

- ✔ 100% INCREASE IN PRODUCTIVITY
- ✔ 100% PERSONALISATION
- ✔ 100% INTEGRATION
- ✔ 50% SPACE SAVED
- ✔ 0 RISKS FOR OPERATORS

WINSTORE +  
Sizing

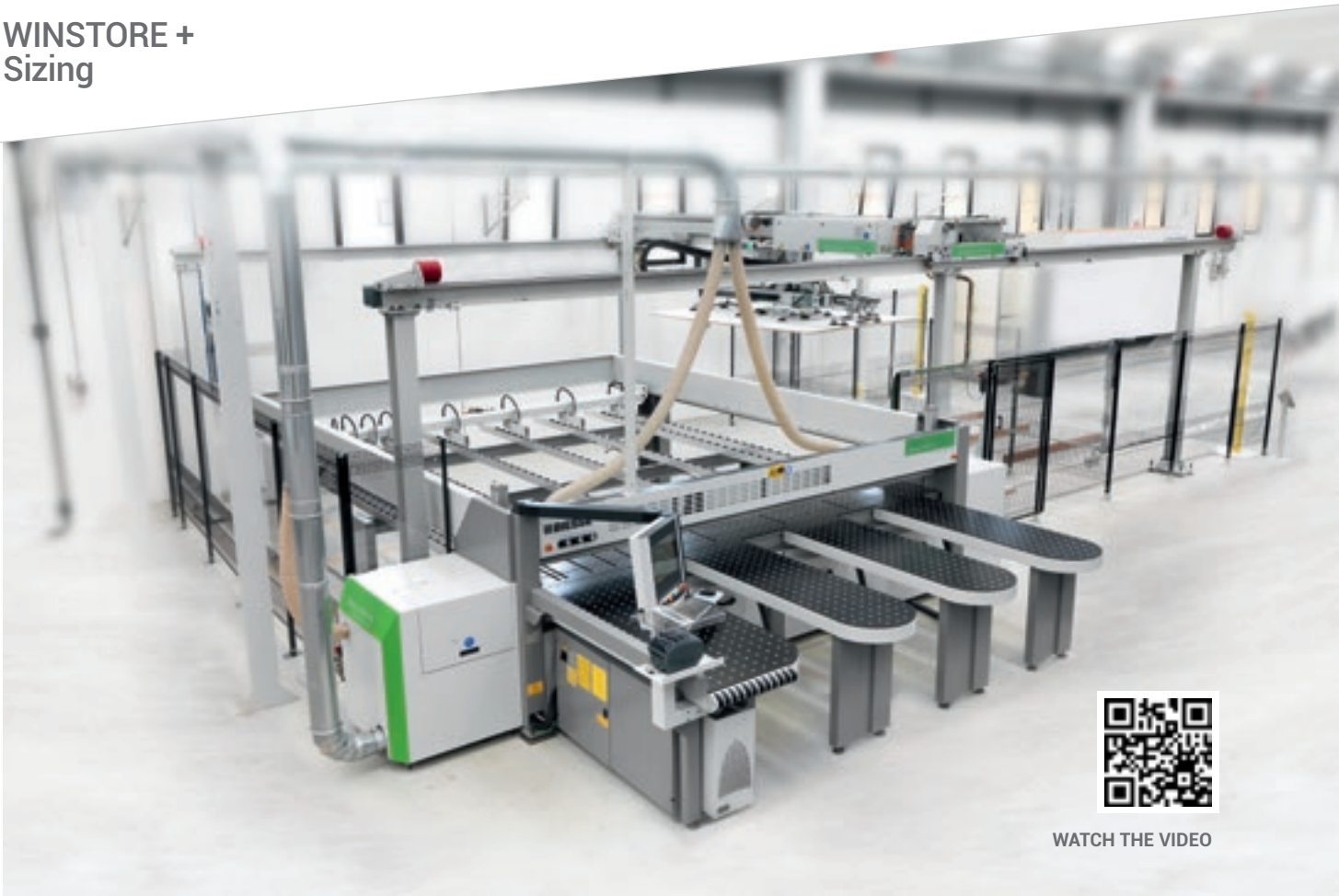

WATCH THE VIDEO

WINSTORE + Flexible cutting



WATCH THE VIDEO

# INTEGRATION OF INFORMATION FLOW

## SUPERVISION SOFTWARE.

Biesse supplies an integrated software program for the management (handling, identification and labelling) of panels to be processed, as well as waste material and off-cuts which can be recycled for new products.

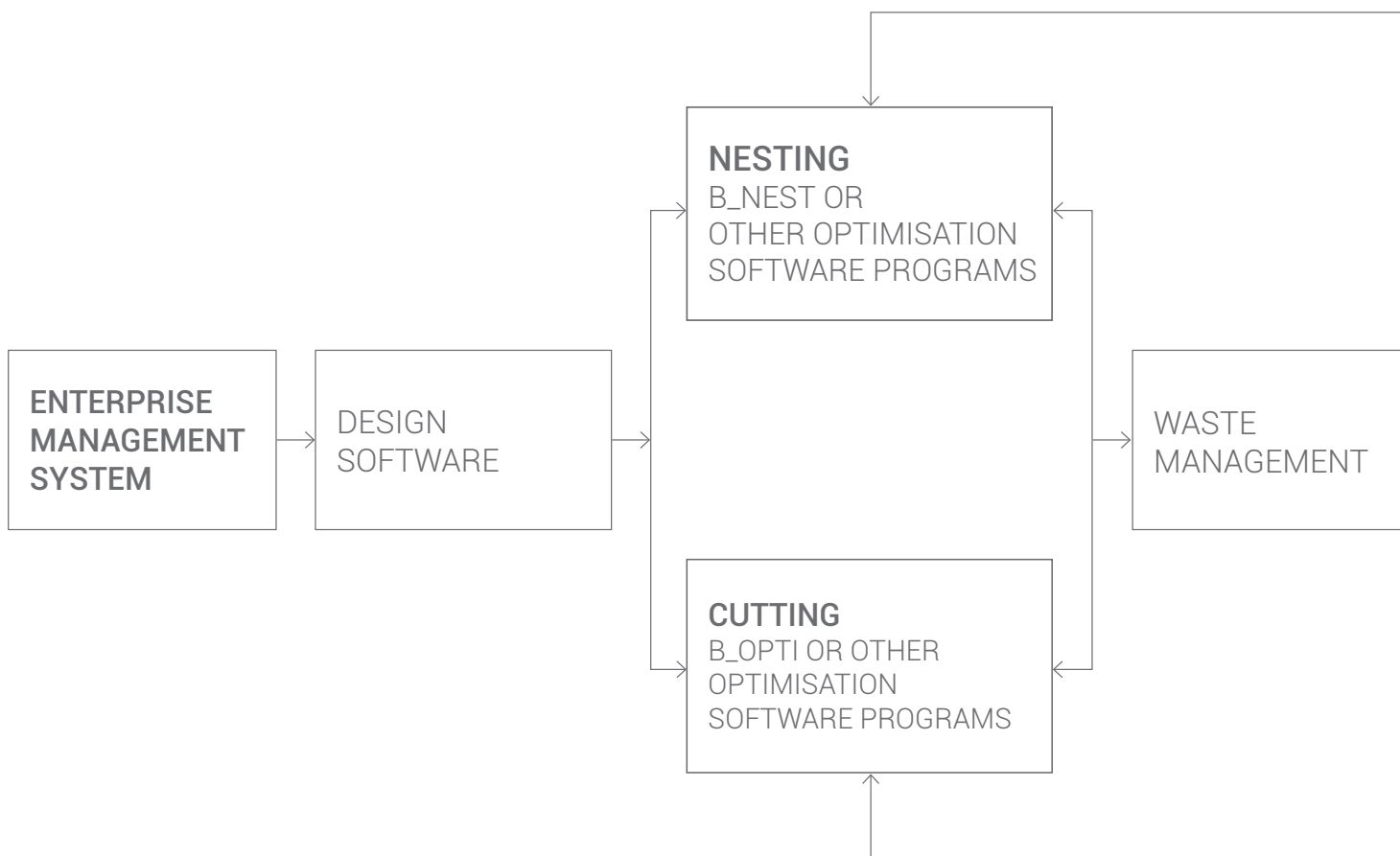



FULL INTEGRATION OF CELL SOFTWARE  
WITH PLANT ENTERPRISE MANAGEMENT SYSTEM.

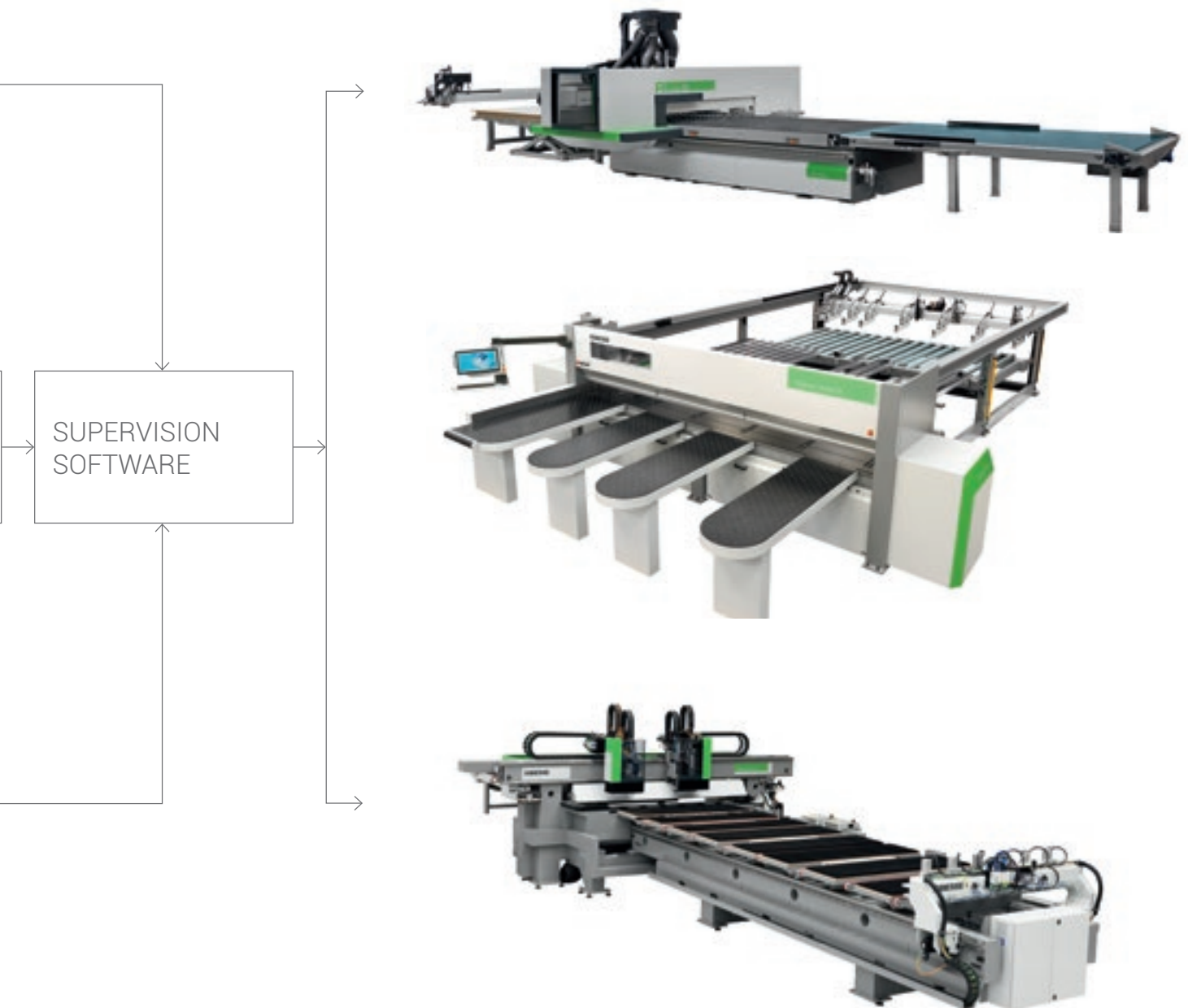

# CUSTOMER CARE IS WHO WE ARE

**SERVICES** is a new experience for our customers, to offer not just excellent technology but the added value of an increasingly direct connection with the company, the professionals who work there and the experience they embody.



## **ADVANCED DIAGNOSTICS**

Digital channels for remote interaction online 24/7. Always ready to intervene on-site seven days a week.



## **A WORLDWIDE NETWORK**

39 branch offices, over 300 certified agents, retailers in 120 countries, and spare parts warehouses in America, Europe and the Far East.



## **SPARE PARTS AVAILABLE IMMEDIATELY**

Identification, shipping and delivery of spare parts for every need.



## **EVOLVED TRAINING OPPORTUNITIES**

Lots of on-site, online and classroom training modules for personalised growth.



## **VALUABLE SERVICES**

A wide range of services and software packages to help our customers achieve continuous improvements in performance.

## AN EXCELLENT LEVEL OF SERVICE

**+550**

HIGHLY SPECIALISED  
TECHNICIANS AROUND  
THE WORLD, READY TO HELP  
CUSTOMERS WITH EVERY  
NEED

**90%**

OF MACHINE DOWN CASES  
WITH RESPONSE TIME  
UNDER 1 HOUR

**+100**

EXPERTS IN DIRECT  
CONTACT THROUGH  
REMOTE CONNECTIONS  
AND TELESERVICE

**92%**

OF SPARE PARTS ORDERS  
FOR MACHINE DOWNTIME  
PROCESSED WITHIN 24  
HOURS

**+50.000**

ITEMS IN STOCK IN THE  
SPARE PARTS WAREHOUSES

**+5.000**

PREVENTIVE MAINTENANCE  
VISITS

**80%**

OF SUPPORT REQUESTS  
SOLVED ONLINE

**96%**

OF SPARE PARTS ORDERS  
DELIVERED IN FULL ON TIME

**88%**

OF CASES SOLVED WITH  
THE FIRST ON-SITE VISIT

# MANAGING PRODUCTION IN A SIMPLE, USER-FRIENDLY MANNER

**SMART  
CONNECTION**  
Powered by Retuner



**SMARTCONNECTION IS A SOFTWARE PACKAGE FOR MANAGING JOB ORDERS WITHIN THE COMPANY - FROM THE GENERATION PHASE TO SCHEDULING AND ACTUAL PRODUCTION START-UP - IN JUST A FEW SIMPLE, INTUITIVE STEPS.**

**THANKS TO SMARTCONNECTION, THE PRODUCTION SITE MACHINES CAN BE LINKED UP TO TRANSFORM THE COMPANY INTO A 4.0 ENTITY..**



SmartConnection is a web-based solution that can be used by any device.

MANAGE THE JOB ORDER

PLAN

SCHEDULE

WORK



Biesse is extending SmartConnection across all geographical areas.  
To check availability in your country, get in touch with your commercial contact.

# SOPHIA

GREATER VALUE FROM MACHINES

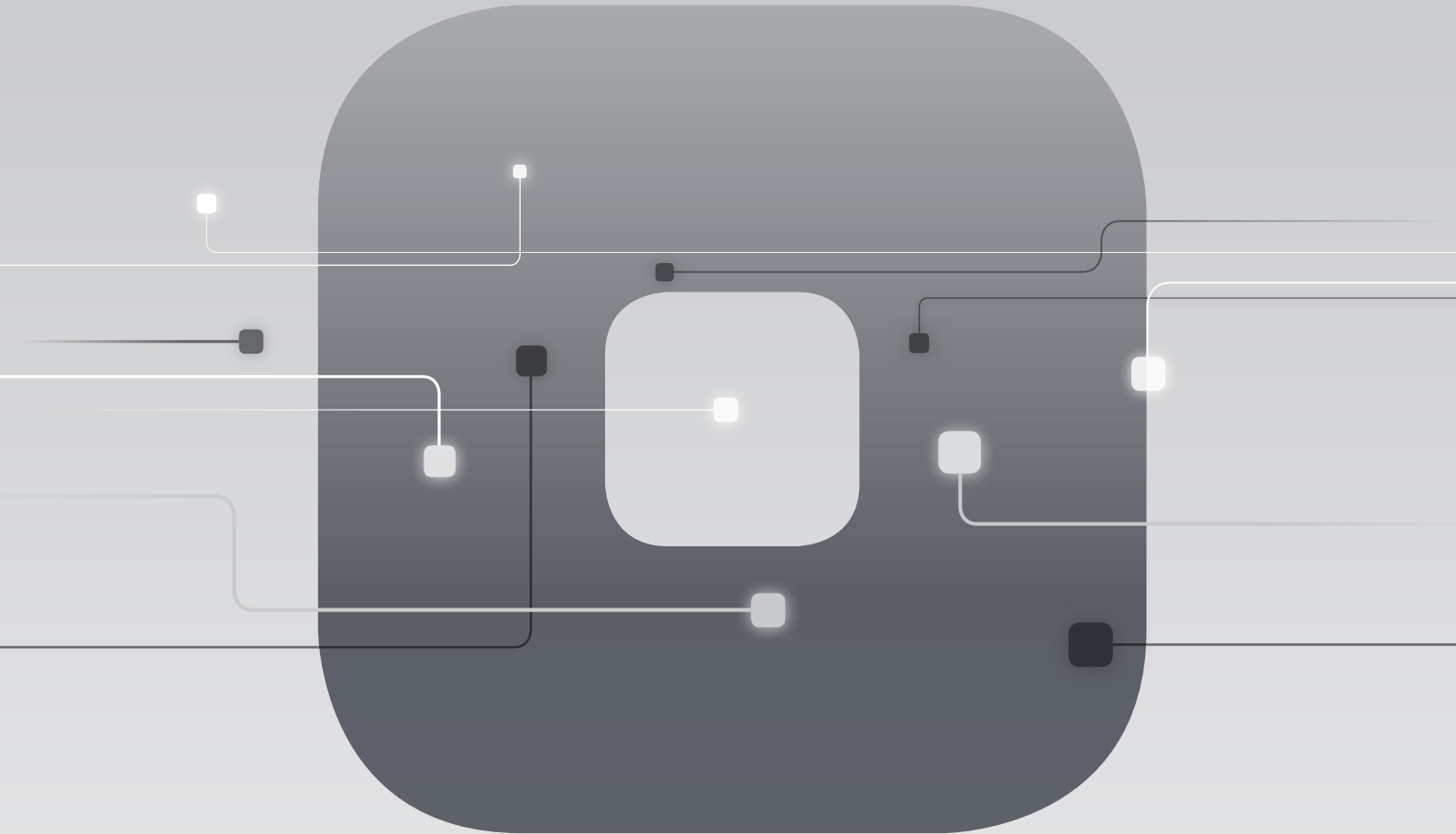

The Biesse IoT platform which enables customers to access an extensive range of services to streamline and rationalise their work management processes.

□ SERVICES

□ PROACTIVITY

□ ANALYSIS



in collaboration with **accenture**

# MADE WITH BIESSE

## BATHROOM FURNISHINGS, TAILOR-MADE MAGIC

**"We are convinced that it's only when tradition and enthusiasm meet research and technology that true excellence is produced".**

At the crossroads between Romagna, Umbria and Tuscany, right in the heart of Italy, there's a magical land whose beauty is as authentic as it is legendary. This enduring beauty – marked by genuine manual skills – lives on thanks to artisan workmanship, traditional attention to detail, and the unique art that only skilled hands can truly produce. It's the perfect setting for BMT Bagni, a company from Pesaro that specialises in the production of bathroom furniture, a tangible expression of the magical essence that blends quality and aesthetics with innovative materials and designs.

Merli and Tomassini originally started out in 1971, producing accessories for furniture, and only later decided to focus on bathroom furniture. The decision proved successful, and the company now exports to 15 Countries - a trend that continues to grow. The company recently in-

augurated a new plant that spans nearly 10,000 square metres, to boost production and pair cutting-edge technology with high quality standards and competitive prices. BMT Bagni furnishings feature *recherché* solutions and are often signed by prestigious designers: "We rely on Italian architects, whose designs are unique and patented, for the creation of truly designer product lines", states **Marco Merli**, Product Manager and R&D/Technical Department Director, not to mention the son of one of the two historic founders. Today, BMT Bagni employs 32 people, with an annual revenue of 3.8 million euros in 2016. The company supplies the best showrooms for bathroom furniture both in Italy and abroad and serves as a contract supplier, providing tailor-made bathroom furniture for houses and businesses. Historic expertise and the drive for innovation sum up what has always been the BMT Bagni vision. As Marco puts it, "We are convinced that it's only when tradition and enthusiasm meet research and technology that true excellence is produced".

### Combining form and function

From the modern to the classic, every style stands out thanks to skilled artisanship perfected over the years: BMT collections are the perfect example of elegant and cutting-edge designs responding to functional needs. They are the perfect answer to the changing demands of everyday life, and a source of new connections that engage the senses. "We believe," Marco explains, "that bathroom furniture is now an integral part of an environment that has become the temple of physical well-being, a place where elegant lines, lighting and sensations all come together". Modularity and personalisation are the unique strengths of BMT, along with a wide range of finishes, materials and colours used to customise the bathroom for each customer. They are the essence of Marco refers to as the tailor-made strategy: "This is how we design and craft the product to fit the customer's needs while striving for perfection".

## BIESSE IS A VERITABLE STRATEGIC PARTNER, NOT A SIMPLE SUPPLIER OF MACHINERY



**Marco Merli**  
*Product Manager*

**BMTBAGNI.IT**



Founded in Italy,  
international native.

We are an international company that manufactures integrated lines and machines to process wood, glass, stone, plastic and composite materials and what will come next.

Thanks to our rooted competence nurtured by an ever-growing worldwide network, we support your business evolution – empowering your imagination.

Master of materials, since 1969.

We simplify your  
manufacturing  
process to make  
the potential of  
any material  
shine.



Join the  
Biesse world.

[biesse.com](https://www.biesse.com)



